

FORA[®]

Diamond PRIMA

Blood Glucose Monitoring System

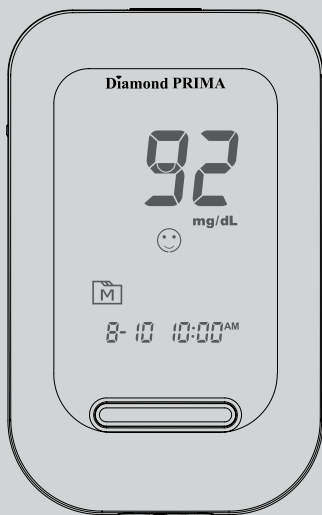

Owner's Manual

Dear FORA Diamond PRIMA System Owner:

Thank you for purchasing the **FORA Diamond PRIMA** Blood Glucose Monitoring System. This manual provides important information to help you to use the system properly. Before using this product, please read the following contents thoroughly and carefully.

Regular monitoring of your blood glucose levels can help you and your doctor gain better control of your diabetes. Due to its compact size and easy operation, you can use the **FORA Diamond PRIMA** Blood Glucose Monitoring System to easily monitor your blood glucose levels by yourself anywhere, any time.

If you have other questions regarding this product, please contact the place of purchase or call the Customer Care Line.

IMPORTANT SAFTY INSTRUCTIONS READ BEFORE USE

1. Use this device **ONLY** for the intended use described in this manual.
2. Do **NOT** use accessories which are not specified by the manufacturer.
3. Do **NOT** use the device if it is not working properly or if it is damaged.
4. Do **NOT** use the equipment in places where aerosol sprays are being used or where oxygen is being administered.
5. Do **NOT** under any circumstances use the device on newborns or infants.
6. This device does **NOT** serve as a cure for any symptoms or diseases. The data measured is for reference only.
7. Before using this device to test blood glucose, read all instructions thoroughly and practice the test. Carry out all the quality control checks as directed.
8. Keep the device and testing equipment away from young children. Small items such as the battery cover, batteries, test strips, lancets and vial caps are choking hazards.
9. Use of this instrument in a dry environment, especially if synthetic materials are present (synthetic clothing, carpets etc.) may cause damaging static discharges that may cause erroneous results.
10. Do **NOT** use this instrument in close proximity to sources of strong electromagnetic radiation, as these may interfere with the accurate operation.

KEEP THESE INSTRUCTIONS IN A SAFE PLACE

TABLE OF CONTENTS

BEFORE YOU BEGIN	06
Important Information	06
Intended Use	07
Test Principle	07
Meter Overview	08
Display Screen	09
Test Strip	10
Setting the Meter	11
THE FOUR MEASURING MODES	14
Control Solution Testing	15
Performing a Control Solution Test	15
TESTING WITH BLOOD SAMPLE	18
Preparing the Puncture Site	18
Alternative Site Testing	20
Performing a Blood Glucose Test	21
METER MEMORY	24
Reviewing Test Results	24
Reviewing Blood Glucose Day Average Results	25
Downloading Results onto a Computer	26
MAINTENANCE	27
Battery	27
Caring for Your Meter	28
Caring for Your Test Strips	29
Important Control Solution Information	30
SYSTEM TROUBLESHOOTING	31
Result Readings	31
Error Messages	32
Troubleshooting	33
DETAILED INFORMATION	34
SYMBOL INFORMATION	35
SPECIFICATIONS	36

BEFORE YOU BEGIN

Important Information

- Severe dehydration and excessive water loss may cause readings which are lower than actual values. If you believe you are suffering from severe dehydration, consult a healthcare professional immediately.
- If your blood glucose results are lower or higher than usual, and you do not have any symptoms of illness, first repeat the test. If you have symptoms or continue to get results which are higher or lower than usual, follow the treatment advice of your healthcare professional.
- Use only fresh whole blood samples to test your blood glucose. Using other substances will lead to incorrect results.
- If you are experiencing symptoms that are inconsistent with your blood glucose test results and you have followed all the instructions given in this owner's manual, contact your healthcare professional.
- We do not recommend using this product on severely hypotensive individuals or patients in shock. Readings which are lower than actual values may occur for individuals experiencing a hyperglycaemic-hyperosmolar state, with or without ketosis. Please consult the healthcare professional before use.
- The measurement unit used for indicating the concentration of blood or plasma glucose can either have a weight dimension (mg/dL) or a molarity (mmol/L). The approximate calculation rule for conversion of mg/dL in mmol/L is:

mg/dL	Divided by 18	= mmol/L
mmol/L	Times 18	= mg/dL

For example;

1) $120 \text{ mg/dL} \div 18 = 6.6 \text{ mmol/L}$

2) $7.2 \text{ mmol/L} \times 18 = 129 \text{ mg/dL}$ approximately.

Intended Use

This system is intended for use outside the body (*in vitro* diagnostic use) by people with diabetes at home and by health care professionals in clinical settings as an aid to monitoring the effectiveness of diabetes control. It is intended to be used for the quantitative measurement of glucose (sugar) in samples of venous whole blood and fresh capillary whole blood (from the finger, palm, forearm, upper arm, calf and thigh). It should not be used for the diagnosis of diabetes, or testing on newborns.

Professionals may test with capillary and venous blood sample; home use is limited to capillary whole blood testing. Use only heparin for anticoagulation of whole blood.

Test Principle

Your system measures the amount of sugar (glucose) in whole blood. The glucose testing is based on the measurement of electrical current generated by the reaction of glucose with the reagent of the strip. The meter measures the current, calculates the blood glucose level, and displays the result. The strength of the current produced by the reaction depends on the amount of glucose in the blood sample.

Meter Overview

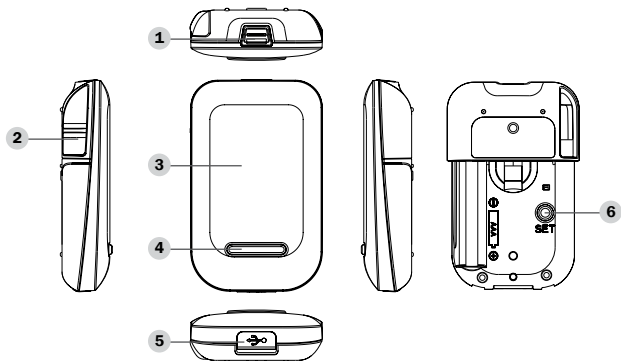

1 Test Slot

Insert test strip here to turn the meter on for testing.

2 Test Strip Ejector

Eject the used strip by pushing up this button.

3 Display Screen

4 Main Button

Enter the meter memory and silence a reminder alarm.

5 Data Port/USB

Download test results with a cable connection.

6 SET Button

Enter and confirm the meter settings.

Display Screen

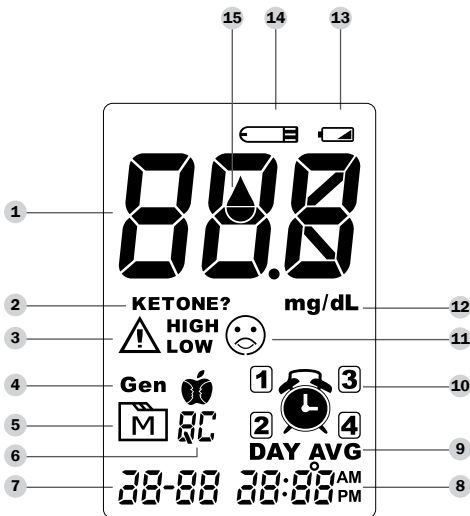

- | | |
|-------------------------|-------------------------|
| 1 Test Result | 9 Day Average |
| 2 Ketone Warning | 10 Alarm Symbol |
| 3 Warning Symbol | 11 Face/Low/High Symbol |
| 4 Testing Mode Symbol | 12 Measurement Unit |
| 5 Memory Symbol | 13 Low Battery Symbol |
| 6 Control Solution Mode | 14 Test Strip Symbol |
| 7 Date | 15 Blood Drop Symbol |
| 8 Time | |

Test Strip

Absorbent Hole

Apply a drop of blood here. The blood will be automatically absorbed.

Confirmation Window

This is where you confirm if enough blood has been applied to the absorbent hole in the strip.

Test Strip Handle

Hold this part to insert the test strip into the slot.

Contact Bars

Insert this end of the test strip into the meter. Push it in firmly until it will go no further.



ATTENTION:

The front side of test strip should face up when inserting test strip.

Test results might be wrong if the contact bar is not fully inserted into the test slot.

NOTE:

The **FORA Diamond PRIMA** monitor should only be used with **FORA Diamond PRIMA** Test Strips. Using other test strips with this meter can produce inaccurate results.

Setting the Meter

Before using your meter for the first time or if you change the meter battery, you should check and update these settings. Make sure you complete the steps below and have your desired settings saved.

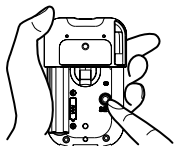

Entering the Setting Mode

Start with the meter off (no test strip inserted). **Press SET.**



1. Setting the date

With the year flashing, press Main button until the correct year appears. Press SET.

With the month flashing, press Main button until the correct month appears. Press SET.



With the day flashing, press Main button until the correct day appears. Press SET.



2. Setting the time format

Press Main button to select the desired time format — 12h or 24h. Press SET.

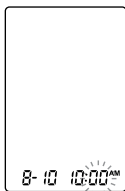

3. Setting the time

With the hour flashing, press Main button until the correct hour appears. Press SET.

With the minute flashing, press Main button until the correct minute appears. Press SET.

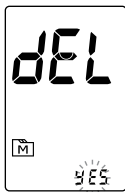

4. Deleting the memory

With “dEL” and a flashing “M” on the display, press Main button and select “no” to keep the results in memory then press SET to skip.

To delete all the results, press Main button and “yes” and “M” are displayed on the meter, press SET to delete the memory.

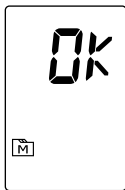
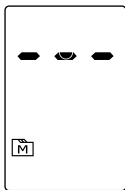

5. Setting the reminder alarm

You may set up any or all of the reminder alarms (1-4). The meter displays “On” or “OFF” and “🔔”, press Main button to turn on or turn off to set the first reminder alarm.

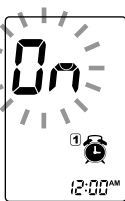

Press Main button to select “On”, then press SET to set the hour. When the hour is flashing, press Main button to add an

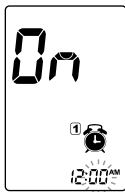
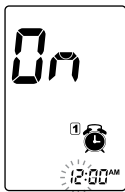

hour. Press SET to confirm and go to minutes, press Main button to add one minute. Hold Main button longer to add faster. Press SET to confirm and go to the next alarm setting.

If you do not want to set an alarm, press SET to skip this step.

If you want to turn off an alarm, find the alarm number by pressing SET in the setting mode, press Main button to change from “ON” to “OFF”.

At the time of your alarm, the meter will beep and automatically turn on. You can press Main button to silence the alarm and insert a test strip to begin testing. If you do not press Main button, the meter will beep for 2 minutes then switch off. If you do not want to test at this time, press Main button to switch off the meter.

Congratulations! You have completed all settings!

NOTE:

- These parameters can **ONLY be changed** in the setting mode.
- If the meter is idle for 3 minutes during the setting mode, it will switch off automatically.

THE FOUR MEASURING MODES

The meter provides you with four modes for measuring, General, AC, PC and QC.

MODES	USE WHEN
General (displays as "Gen")	any time of day without regard to time since last meal
AC	no food intake for at least 8 hours
PC	2 hours after a meal
QC	testing with the control solution

You can switch between each mode by:



- 1.** Start with the meter switched off. Insert a test strip to turn on the meter. The screen will display a flashing "💧" and "Gen".

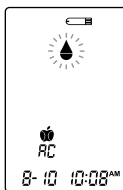
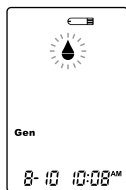

- 2.** Press Main button to switch between General, AC, PC and QC mode.

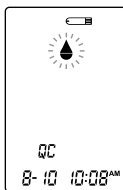
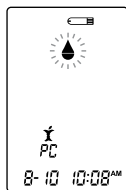

Control Solution Testing

Our Control Solution contains a known amount of glucose that reacts with test strips and is used to ensure your meter and test strips are working together correctly.

Test strips, control solutions, or sterile lancets may not be included in the kit (please check the contents on your product box). They can be purchased separately. Please make sure you have those items needed for a blood glucose test beforehand.

Do a control solution test when:

- you first receive the meter,
- at least once a week to routinely check the meter and test strips,
- you begin using a new vial of test strips,
- you suspect the meter or test strips are not working properly,
- your blood glucose test results are not consistent with how you feel, or if you think the results are not accurate,
- practicing the testing process, or
- you have dropped or think you may have damaged the meter.

Performing a Control Solution Test

You will need:

1 Meter



2 Test Strip





3 Control Solution

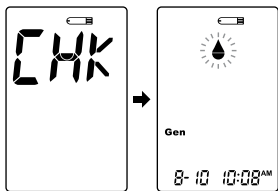



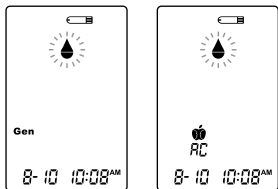

1. Insert the test strip to turn on the meter

Insert the test strip into the meter. Wait for the meter to display “” and “”.



2. Press Main button to mark this test as a control solution test

With “” displayed, the meter will not store your test result in memory. If you press the Main button three times, the “” will disappear and this test is no longer a control solution test.

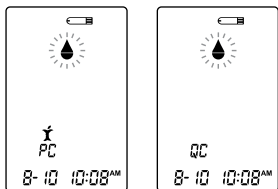

WARNING:

When doing the control solution test, you have to mark it so that the test result will **NOT** mix with the blood glucose **TEST RESULTS** stored in the memory. Failure to do so will mix up the blood glucose test results with the control solution test results in memory.

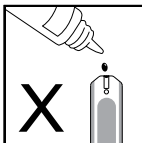
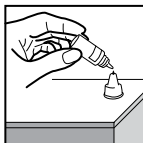

3. Apply control solution

Shake the control solution vial thoroughly before use. Squeeze out a drop and wipe it off, then squeeze out another drop and place it on the tip of the vial cap. Hold the meter to move the absorbent hole of the test strip to touch the drop. Once the confirmation window fills completely, the meter will begin counting down. To avoid contaminating the control solution, do not directly apply control solution onto a strip.

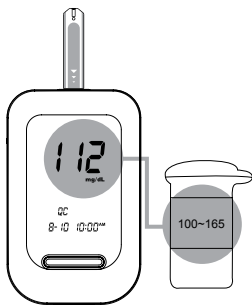

4. Read and compare the result

After counting down to 0, the control solution test result will appear on the display. Compare this result with the range printed on the test strip vial and it should fall within this range. If not, please read the instructions again and repeat the control solution test.

(112 mg/dL = 6.2 mmol/L; 100–165 mg/dL = 5.6–9.2 mmol/L)

Out-of-range results

If you continue to have test results fall outside the range printed on the test strip vial, the meter and strips may not be working properly. Do **NOT** test your blood. Contact the local customer service or place of purchase for help.

NOTE:

- The control solution range printed on the test strip vial is for control solution use only. It is not a recommended range for your blood glucose level.
- See the **Meter Maintenance** section for important information about your control solutions.

TESTING WITH BLOOD SAMPLE

WARNING:

To reduce the chance of infection:

- Never share a lancet or the lancing device.
- Always use a new, sterile lancet. Lancets are for single use only.
- Avoid getting hand lotion, oils, dirt, or debris in or on the lancets and the lancing device.

Preparing the Lancing Device for Blood Testing

Please follow the instructions in the lancing device insert for collecting a blood sample.

Preparing the Puncture Site

Stimulating blood perfusion by rubbing the puncture site before blood extraction has a significant influence on the glucose value obtained. Blood from a site that has not been rubbed exhibits a measurably different glucose concentration than blood from the finger. When the puncture site was rubbed prior to blood extraction, the difference was significantly reduced.

Please follow the suggestions below before obtaining a drop of blood:

- Wash and dry your hands before starting.
- Select the puncture site either at fingertips or another body parts (please see section “Alternative Site Testing” (AST) on how to select the appropriate sites).
- Clean the puncture site using cotton moistened with 70% alcohol and **let it air dry.**
- Rub the puncture site for about 20 seconds before penetration.
- Use a clear cap (included in the kit) while setting up the lancing device.



- **Fingertip testing**

Press the lancing device's tip firmly against the lower side of your fingertip. Press the release button to prick your finger, then a click indicates that the puncture is complete.

- **Blood from sites other than the fingertip**

Replace the lancing device cap with the clear cap for AST. Pull the cocking control back until it clicks. When lancing the forearm, upper arm, hand, thigh, or calf, avoid lancing the areas with obvious veins because of excessive bleeding.

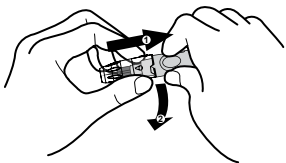

NOTE:

- Choose a different spot each time you test. Repeated punctures at the same spot may cause soreness and calluses.
- Please consult your health care professional before you begin AST.
- It is recommended that you discard the first drop of blood as it might contain tissue fluid, which may affect the test result.

Alternative Site Testing

You can test on a variety of locations on your body.

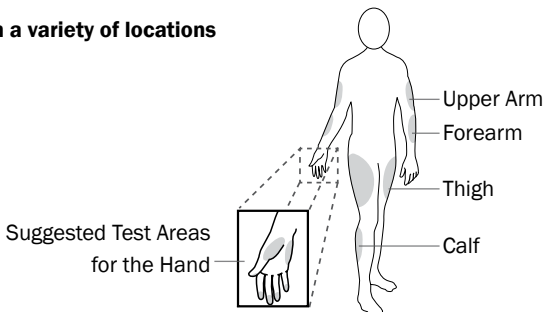

Important:

There are limitations with **AST (Alternative Site Testing)**.

Please consult your health care professional before you perform AST.

When to use AST?

Capillary blood at the fingertip reflects these changes faster than capillary blood at other sites. Thus, when testing blood glucose during or immediately after a meal, physical exercise, or any other event, **take a blood sample from your finger only.**

We strongly recommend that you perform AST **ONLY** at the following times:

- In a pre-meal or fasting state (more than 2 hours since the last meal).
- Two hours or more after taking insulin.
- Two hours or more after exercise.

Do **NOT** use AST if:

- You think your blood glucose is low.
- You are unaware of hypoglycemia.
- You are testing for hyperglycemia.
- Your AST results do not match the way you feel.
- Your routine glucose results often fluctuate.

Performing a Blood Glucose Test

You will need:

1 Meter



2 Test Strip





3 Lancing Device

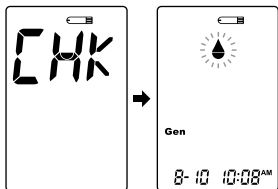

4 Lancet



1. Insert the test strip to turn on the meter

Wait for the meter to display “” and “”.

2. Select the appropriate measuring mode by pressing Main button

For selecting the measurement mode, please refer to the “FOUR MEASURING MODES”.

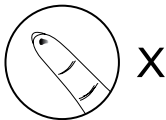
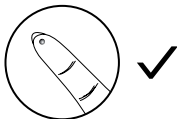

3. Obtaining a blood sample

Use the pre-set lancing device to puncture the desired site. Wipe off the first appeared drop of blood with a clean cotton swab. The size of the drop should be at least as big as  (actual size), which is **0.5** microliter (μL) of volume. Gently squeeze the punctured area to obtain another drop of blood. Be careful **NOT** to smear the blood sample.

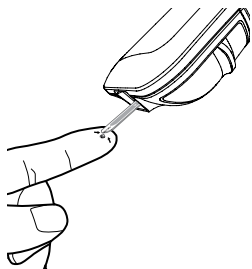

4. Apply the sample

Gently apply the drop of blood to the absorbent hole of the test strip at a titled angle. Confirmation window should be completely filled if enough blood sample has been applied. Do **NOT** remove your finger until you hear a beep sound.

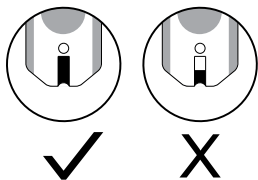

NOTE:

- Do not press the punctured site against the test strip or try to smear the blood.
- If you do not apply a blood sample to the test strip within 3 minutes, the meter will automatically turn off. You must remove and reinsert the test strip to start a new test.
- The confirmation window should be filled with blood before the meter begins to count down. **NEVER** try to add more blood to the test strip after the drop of blood has moved away. **Discard the used test strip and retest with a new one.**
- If you have trouble filling the confirmation window, please contact your health care professional or the local customer service for assistance.



5. Read your result

The result of your blood glucose test will appear after the meter counts down to 0. The blood glucose result will be stored in the memory automatically.
(100 mg/dL = 5.6 mmol/L)

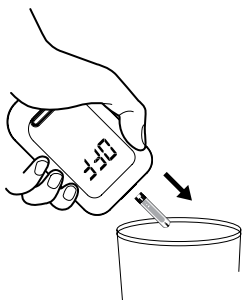

6. Eject the used test strip

Eject the test strip by pushing the eject button on the side. Use a sharp bin to dispose of used test strips. The meter will switch itself off automatically.

Always follow the instructions in the lancet device insert when removing the lancet.

WARNING:

The used lancet and test strip may be biohazardous. Please discard them carefully according to your local regulations.

METER MEMORY

The meter stores the 450 most recent blood glucose test results along with respective dates and times in its memory. To enter the meter memory, **start with the meter switched off.**

Reviewing Test Results

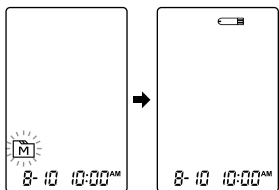

1. Press and release Main button

“M” will appear on the display. Press Main button again, and the first reading you see is the last blood glucose result along with date, time and the measurement mode.

(300 mg/dL = 16.7 mmol/L)

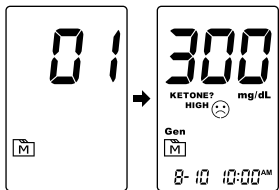

2. Press the Main button to recall the test results stored in the meter each time you press. After the last test result, press Main button again and the meter will be turned off.

(200 mg/dL = 11.1 mmol/L)

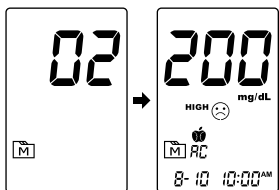

Reviewing Blood Glucose Day Average Results

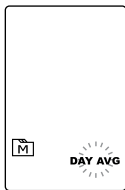
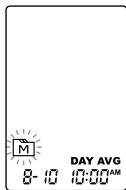

1. Press and release Main button.

When “**M**” appears on the display, keep pressing Main button for 3 seconds until the flashing “**DAY AVG**” appears. Release Main button and then your 7-day average result measured in general mode will appear on the display.

(100 mg/dL = 5.6 mmol/L)

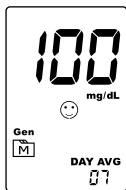

2. Press Main button to review 14-, 21-, 28-, 60- and 90- day average results stored in each measuring mode in the order of Gen, AC, then PC.

3. Exit the meter memory. Keep pressing the Main button and the meter will turn off after displaying the last test result.

NOTE:

- Any time you wish to exit the memory, keep pressing Main button for 5 seconds or leave it without any action for 3 minutes. The meter will switch off automatically.
- Control solution results are **NOT** included in the day average.
- If using the meter for the first time, “—” displays when you recall the test results or review the average result. It indicates that there is no test result in the memory.

Downloading Results onto a Computer

Data Transmission Via Cable

You can use the meter with an USB cable and the Health Care Software System to view test results on your personal computer. To learn more about the Health Care Software System or to obtain an USB cable separately, please contact local customer services or the place of purchase for assistance.

1. Obtaining the required cable and installing the software

To download the Health Care Software System, please visit the ForaCare Suisse AG, website: www.foracare.ch

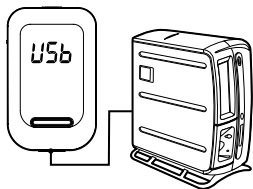

2. Connecting to a personal computer

Connect the cable to a USB port on your computer. With the meter switched off, connect the other end of the USB cable to the meter data port. "USB" will appear on the meter display, indicating that the meter is in communication mode.

3. Data transmission

To transmit data, follow the instructions provided with the software. Results will be transmitted with date and time. Remove the cable and the meter will automatically switch off.

WARNING:

While the meter is connecting to the PC, it will be unable to perform a blood glucose test.

MAINTENANCE

Battery

Your meter comes with one 1.5V AAA size alkaline battery.

Low Battery Signal

The meter will display one of the messages below to alert you when the meter power is getting low.

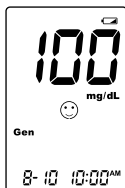

1. The “” appears along with display messages: The meter is functional and the result remains accurate, but it is time to change the battery.

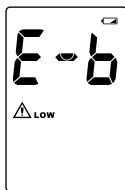

2. The “” appears with E-b, Error and low:

The power is not enough to do a test. Please change the batteries immediately.

Replacing the Battery

To replace the batteries, make sure that the meter is turned off.

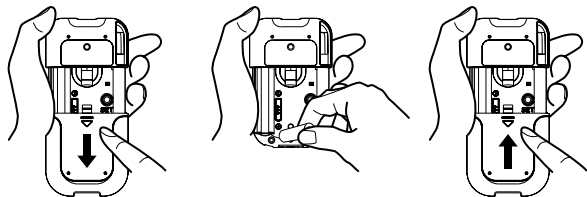

1. Press the edge of the battery cover and lift it up to remove.
2. Remove the old batteries and replace with one 1.5V AAA size alkaline batteries.
3. Close the battery cover. If the battery are inserted correctly, you will hear a “beep” afterwards.

NOTE:

- Replacing the battery does not affect the test results stored in the memory.
- As with all small battery, these batteries should be kept away from children. If swallowed, promptly seek medical assistance.
- Battery might leak chemicals if unused for a long time. Remove the batteries if you are not going to use the device for an extended period (i.e., 3 months or more).
- Properly dispose of the batteries according to your local environmental regulations.

Caring for Your Meter

To avoid the meter and test strips attracting dirt, dust or other contaminants, please wash and dry your hands thoroughly before use.

Cleaning

- To clean the meter exterior, wipe it with a cloth moistened with tap water or a mild cleaning agent, then dry the device with a soft dry cloth. Do **NOT** rinse with water.
- Do **NOT** use organic solvents to clean the meter

Meter Storage

- Storage conditions: -20 °C to 60 °C (-4 °F to 140 °F), below 95% relative humidity.
- Always store or transport the meter in its original storage case.
- Avoid dropping and heavy impact.
- Avoid direct sunlight and high humidity.

Caring for Your Test Strips

- Storage conditions: 2 °C to 32 °C (35.6 °F to 89.6 °F), below 85% relative humidity. Do **NOT** freeze.
- Store your test strips in their original vial only. Do not transfer to another container.
- Store test strip packages in a cool dry place. Keep away from direct sunlight and heat.
- After removing a test strip from the vial, immediately close the vial cap tightly.
- Touch the test strip with clean and dry hands.
- Use each test strip immediately after removing it from the vial.
- Write the opening date on the vial label when you first opened it. Discard remaining test strips after 3 months.
- Do not use test strips beyond the expiry date. This may cause inaccurate results.
- Do not bend, cut, or alter a test strip in any way.
- Keep the strip vial away from children since the cap and the test strip may be a choking hazard. If swallowed, promptly see a doctor for help.

For further information, please refer to the test strip package insert.

Important Control Solution Information

- Use only our control solutions with your meter.
- Do not use the control solution beyond the expiry date or 3 months after first opening. Write the opening date on the control solution vial and discard the remaining solution after 3 months.
- It is recommended that the control solution test be done at room temperature 20°C to 25°C (68°F to 77°F). Make sure your control solution, meter, and test strips are at this specified temperature range before testing.
- Shake the vial before use, discard the first drop of control solution, and wipe off the dispenser tip to ensure a pure sample and an accurate result.
- Store the control solution tightly closed at temperatures between 2°C to 30°C (36°F to 86°F). Do **NOT** freeze.



SYSTEM TROUBLESHOOTING

If you follow the recommended action but the problem persists, or error messages other than the ones below appear, please call your local customer service. Do not attempt to repair yourself and never try to disassemble the meter under any circumstances.

Result Readings

MESSAGE	WHAT IT MEANS		
Lo	< 20 mg/dL (1.1 mmol/L).		
LOW ☹️	20–69 mg/dL (1.1–3.8 mmol/L)		
😊	AC 🍏	PC 🍷	Gen
	70–129 mg/dL (3.9–7.2 mmol/L)	70–179 mg/dL (3.9–9.9 mmol/L)	70–119 mg/dL (3.9–6.6 mmol/L)
HIGH ☹️	AC 🍏	PC 🍷	Gen
	130–239 mg/dL (7.2–13.3 mmol/L)	180–239 mg/dL (9.9–13.3 mmol/L)	120–239 mg/dL (6.7–13.3 mmol/L)
KETONE? ☹️	≥ 240 mg/dL (13.3 mmol/L)		
Hi	> 600 mg/dL (33.3 mmol/L)		

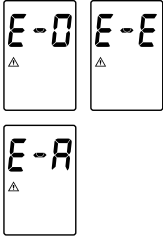
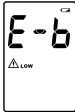
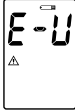
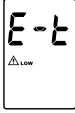
Error Messages

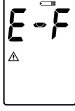
MESSAGE	WHAT IT MEANS	WHAT TO DO
 <p>The image shows three digital display screens. The first two show 'E-0' and 'E-E' with a small triangle icon below the 'E'. The third shows 'E-A' with a small triangle icon below the 'E'.</p>	<p>Problem with the meter.</p>	<p>Repeat the test with a new test strip. If the meter still does not work, please contact the customer service for assistance.</p>
 <p>The image shows a digital display screen with 'E-b' and a small triangle icon below the 'E'. A battery icon with a minus sign is visible in the top right corner.</p>	<p>Appears when the batteries cannot provide enough power for a test.</p>	<p>Replace the batteries immediately.</p>
 <p>The image shows a digital display screen with 'E-U' and a small triangle icon below the 'E'. A battery icon with a minus sign is visible in the top right corner.</p>	<p>Appears when a used test strip is inserted.</p>	<p>Repeat with a new test strip.</p>
 <p>The image shows a digital display screen with 'E-t' and a small triangle icon below the 'E'. A battery icon with a minus sign is visible in the top right corner.</p>	<p>Appears when ambient temperature is below system operation range.</p>	<p>System operation range is 10°C to 40°C (50°F to 104°F). Repeat the test after the meter and test strip are in the above temperature range.</p>
 <p>The image shows a digital display screen with 'E-t' and a small triangle icon below the 'E'. A battery icon with a plus sign is visible in the top right corner.</p>	<p>Appears when ambient temperature is above system operation range.</p>	
 <p>The image shows a digital display screen with 'E-F' and a small triangle icon below the 'E'. A battery icon with a plus sign is visible in the top right corner.</p>	<p>Appears when test strip is removed while counting down, or insufficient blood volume.</p>	<p>Repeat the test with a new test strip.</p>

Troubleshooting

1. If the meter does not display a message after inserting a test strip:

POSSIBLE CAUSE	WHAT TO DO
Battery exhausted.	Replace the battery.
Test strip inserted upside down or incompletely.	Insert the test strip with contact bars end first and facing up.
Defective meter or test strips.	Please contact customer services.

2. If the test does not start after applying the sample:

POSSIBLE CAUSE	WHAT TO DO
Insufficient blood sample.	Repeat the test using a new test strip with larger volume of blood sample.
Defective test strip.	Repeat the test with a new test strip.
Sample applied after automatic switch-off (2 minutes after last user action).	Repeat the test with a new test strip. Apply sample only when flashing “  ” appears on the display.
Defective meter.	Please contact customer services.

3. If the control solution testing result is out of range:

POSSIBLE CAUSE	WHAT TO DO
Error in performing the test.	Read instructions thoroughly and repeat the test again.
Control solution vial was poorly shaken.	Shake the control solution vigorously and repeat the test again.
Expired or contaminated control solution.	Check the expiry date of the control solution.
Control solution that is too warm or too cold.	Control solution, meter, and test strips should be at room temperature 20 °C to 25 °C (68 °F to 77 °F) before testing.
Defective test strip.	Repeat the test with a new test strip.
Meter malfunction.	Please contact customer services.

DETAILED INFORMATION















The meter provides you with plasma equivalent results.

Time of day	Normal plasma glucose range for people without diabetes (mg/dL)
Fasting and before meal	< 100 mg/dL (5.6 mmol/L)
2 hours after meals	< 140 mg/dL (7.8 mmol/L)

Source: American Diabetes Association (2010). Clinical Practice Recommendations. Diabetes Care, 33 (Supplement 1): S1–S100.

Please consult your doctor to determine a target range that works best for you.

SYMBOL INFORMATION

SYMBOL	REFERENT	SYMBOL	REFERENT
	<i>In vitro</i> diagnostic medical device		Use within 3 months after first opening
	Do not reuse		Batch code
	Consult instructions for use		Manufacturer
	Keep away from sunlight		Serial number
	Keep dry		Caution, consult accompanying documents
	Temperature limitation		Sterilized using irradiation
	Use by/ Expiry date		Do not use if package is damaged

SPECIFICATIONS

Model No.: FORA DM10

Dimension & Weight: 86 x 53.6 x 19.5 mm, 52.4 g (without battery)

Power Source: One 1.5V AAA alkaline battery

Display: LCD

Memory: 450 measurement results with respective date and time

External Output: USB

Auto electrode insertion detection

Auto sample loading detection

Auto reaction time count-down

Auto switch-off after 3 minutes without action

Temperature Warning

Operating Condition:

2°C to 32°C (35.6°F to 89.6°F), below 85% R.H. (non-condensing)

Storage/Transportation Conditions:

-20°C to 60°C (-4°F to 140°F), below 95% R.H.

Measurement Units: mg/dL

Measurement Range: 20 to 600 mg/dL (1.1 to 33.3 mmol/L)

This device has been tested to meet the electrical and safety requirements of: IEC/EN 61010-1, IEC/EN 61010-2-101, EN 61326-1, IEC/EN 61326-2-6.



Five-Year Warranty Registration Card

Complete this warranty card and mail it promptly

Name

Street Address

APT#

City

Country

State / Zip

Home Telephone

Meter Serial Number

(See label on back of meter)

Date of Purchase

(Month-Day-Year)

I would like to receive special offers and updates from FORA

ForaCare Suisse AG

www.foracare.ch

PLACE
STAMP
HERE

ForaCare Suisse AG

Neugasse 55, 9000 St. Gallen, Switzerland

Diamond PRIMA

Blood Glucose Monitoring System

 **ForaCare Suisse AG**
CH-9000 St. Gallen
www.foracare.ch

For self-testing

